

Installation instructions

AUDI 2.5 TFSI

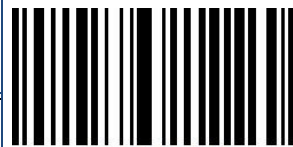

14109602

The product described in the guidance was developed, manufactured and controlled considering the necessary safety requirements.

The product must be installed properly to ensure a proper function and avoid danger for persons and things.

Please read this installationguide inclusive safety instructions carefully.

Scope of supply:

Quantity	article
1x	Tuningbox
1x	loom
1x	Bridge plug
1x	Fastening kit

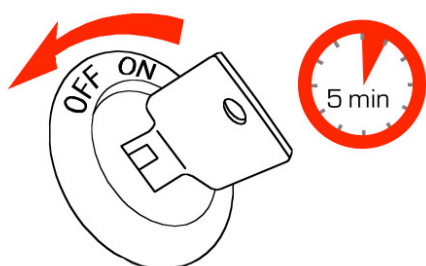

1. Open the hood.
2. Turn the ignition off!
3. Remove the ignitionkey!
4. Close and lock all doors!
5. Do not open any doors while installing the tuning-kit!
6. Wait 5 minutes before beginning the installation



In order to avoid damages at electronic vehicle components, you have to be sure that you have done all necessary methods for **electrostatic discharge** .

Install the electronic in an **waterproof** and **vibrati-onless** place. Do not make any changes at the tuning-kit!

Do not expand or shorten the loom.

Installation instructions

AUDI 2.5 TFSI

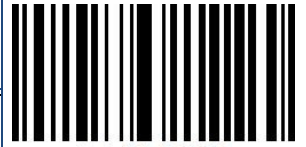

14109602

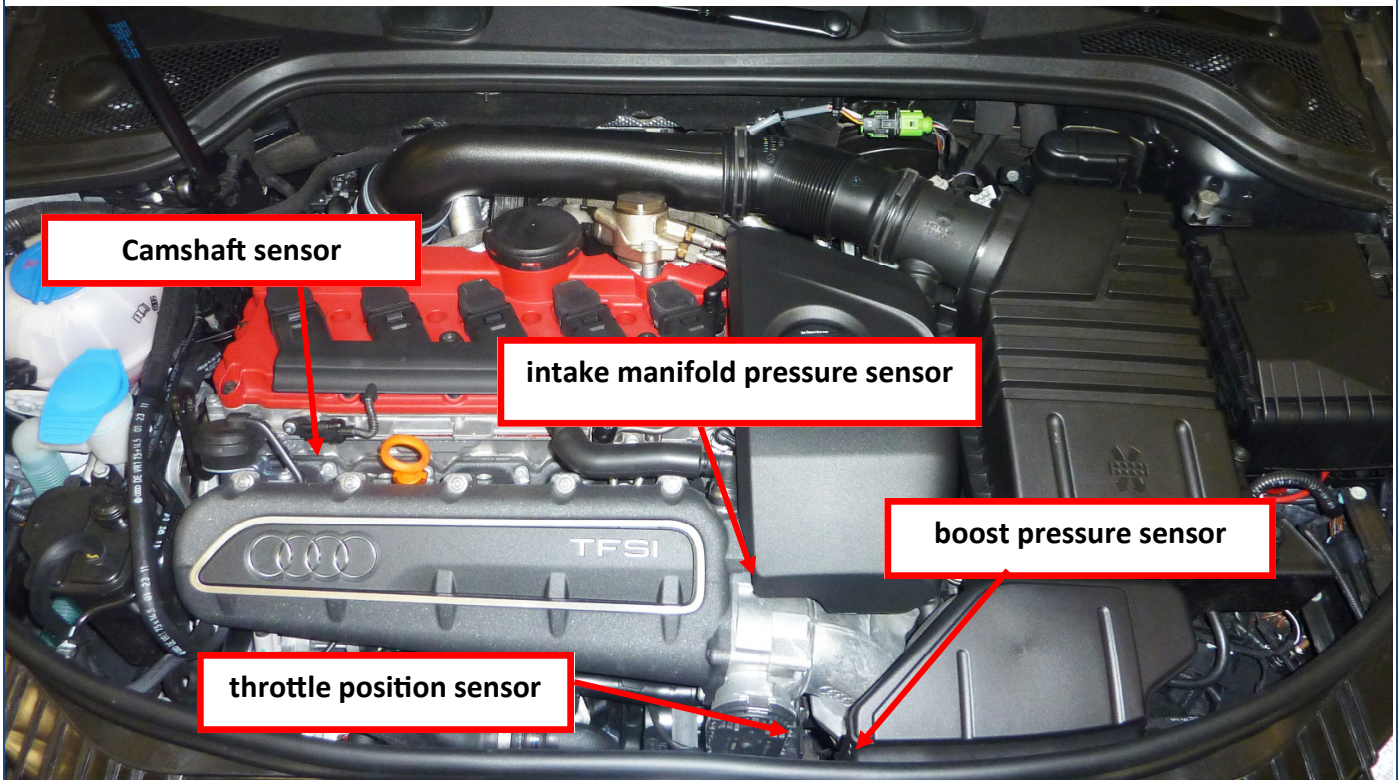

Overview:

The tuningkit has to be attached to the following points:

- **intake manifold pressure sensor**
- **Boost pressure sensor**
- **Camshaft sensor**
- **Throttle position sensor**

Required tools:

- **Screwdriver**

Preparation:

- Move the individual strands of the loom to the associated plug connectors
- Put the required tools by your side (if needed)
- Take the fastening material at your side

Installation instructions

AUDI 2.5 TFSI

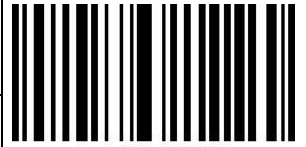

14109602

Preparation



- ◇ To easily get to the manifold air pressure sensor you have to remove the cover.

Connecting to the intake manifold pressure sensor

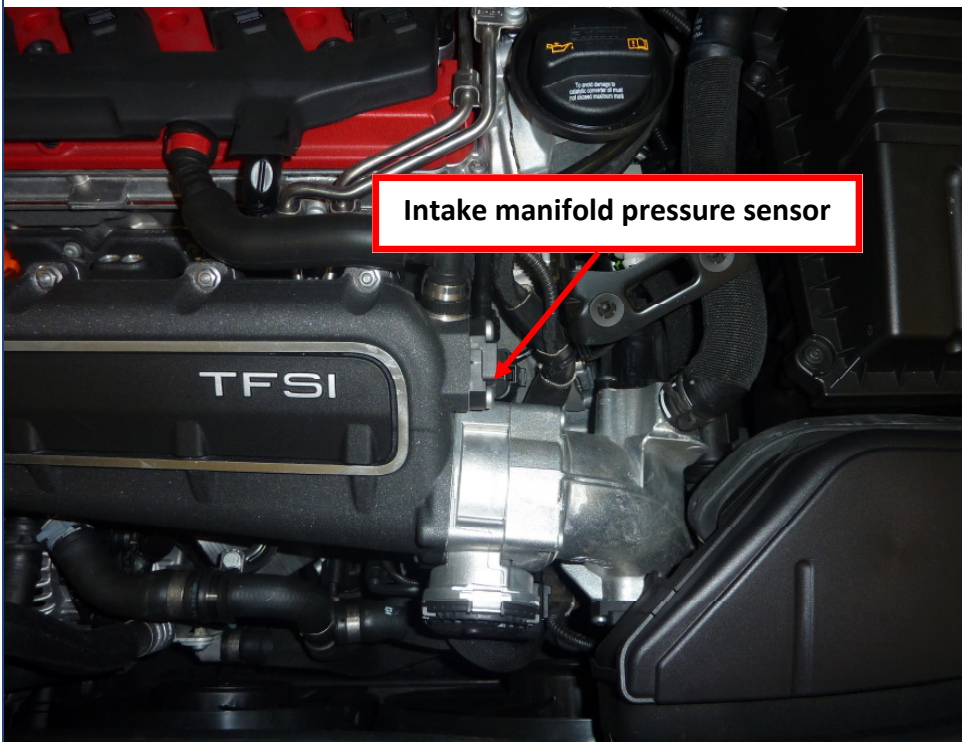

- ◇ First, loosen the plug connector at the intake manifold pressure sensor.
- ◇ Then please connect the supplied cable with the original intake manifold pressure sensor plug
- ◇ Finally, insert the supplied cable to the intake manifold pressure sensor.

Installation instructions

AUDI 2.5 TFSI

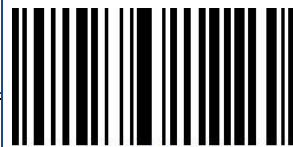

14109602

Connecting at the throttle position sensor



- ◇ Disconnect the plug from the throttle position sensor.
- ◇ Attach the throttle position plug to the new loom
- ◇ Connect the plug of the new loom at the throttle position sensor

Connecting at the boost pressure sensor

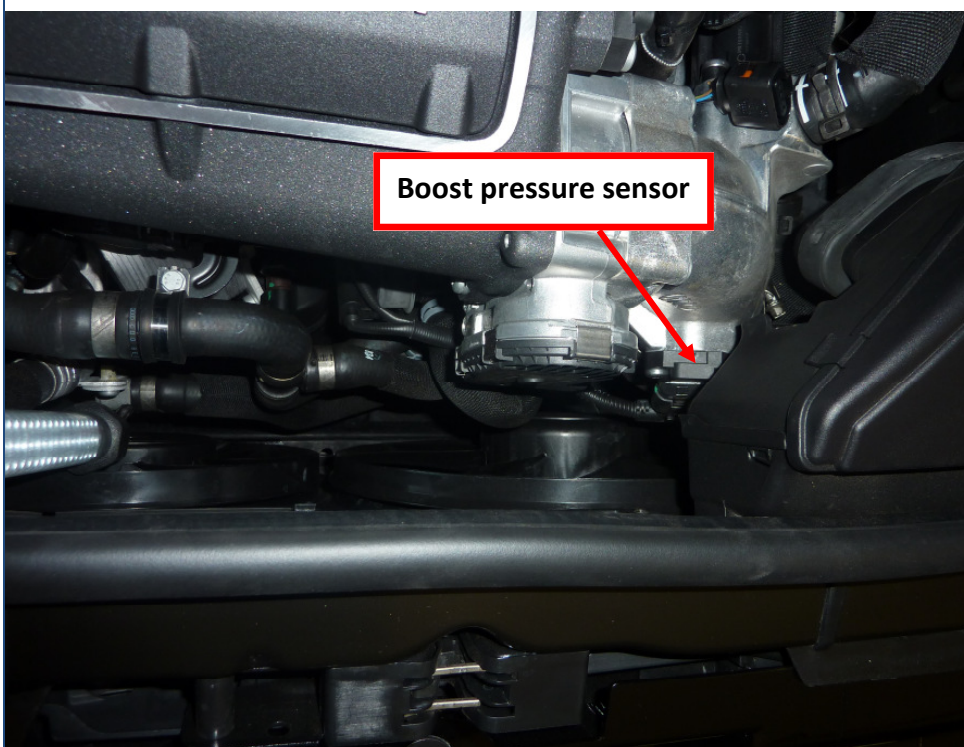

- ◇ Disconnect the plug from the boost pressure sensor.
- ◇ Attach the boost pressure sensor plug to the new loom
- ◇ Connect the plug of the new loom to the boost pressure sensor

Installation instructions

AUDI 2.5 TFSI

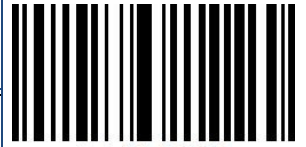

14109602

Connecting to the camshaft sensor



- ◇ Disconnect the plug from the camshaft sensor.
- ◇ Attach the camshaft sensor plug to the new loom
- ◇ Connect the plug of the new loom to the camshaft sensor

Connecting to the Chiptuning-Box

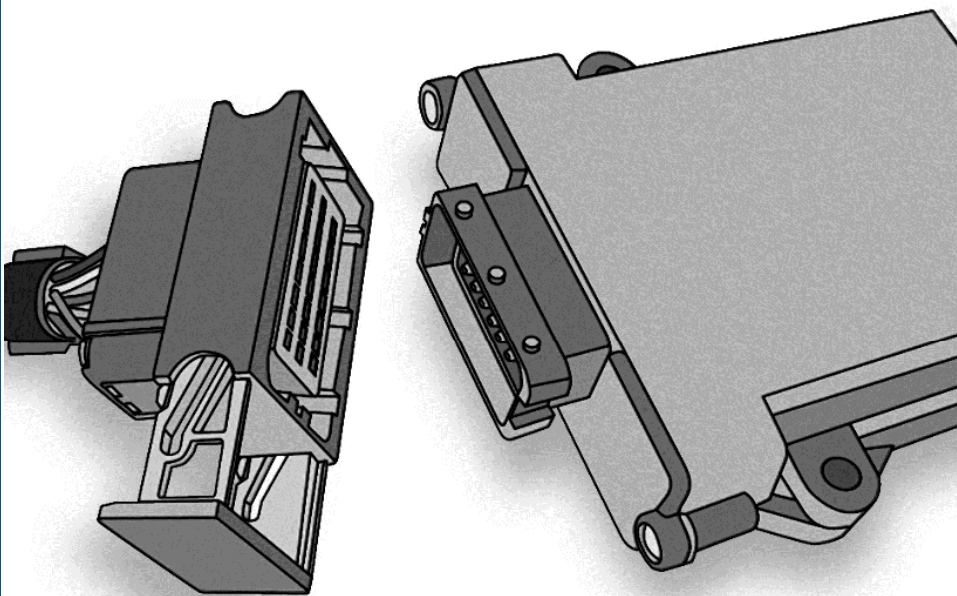

- ◇ Finally install the cable towards a suitable position
- ◇ The plugs must be engaged, so that a safe connection is ensured
- ◇ Fix the cable with cable ties
- ◇ Connect the tuningbox to the new loom